

# SEATTLE SERIES TOWEL WARMER

Chauffe-serviettes  
Calentador de toallas



● POLISHED CHROME (PC)  
SEA-0800600-PC

### STOCKED FINISHES



● BRUSHED NICKEL (BN)  
SEA-0800600-BN



● POLISHED NICKEL (PN)  
SEA-0800600-PN



● MATTE BLACK (MB)  
SEA-0800600-MB



● BRUSHED BRASS (BB)  
SEA-0800600-BB



● PROSECCO BRONZE (PB)  
SEA-0800600-PB



● MATTE WHITE (MW)  
SEA-0800600-MW

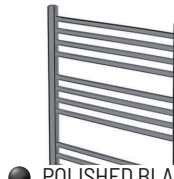

● POLISHED BLACK CHROME (PBC)  
SEA-0800600-PBC

### SPECIAL FINISH ORDER

Available only for SEA-0800600 in select finishes. (See page 3)

### FEATURES

- Wall Mounted
- Hardwire Installation Kit
- Mounting Instruction
- All Electric and Oil Filled
- Cover Plates

Timers available separately (not included)

### SIZES

- 480 x 900 mm
- 540 x 500 mm
- 800 x 500 mm
- 1200 x 600 mm

### SEE PAGE 2 FOR SPECIFICATION DRAWINGS

Product Code	Finishes	Sizes (mm)		Sizes (Inches)		Output ( Watts / BTU)	Element Size	Number of Bars
		Height	Width	Height	Width			
SEA-0800600	PC, BN, PN, BB, PB, PBC	800	600	31.5	23.62	288 / 981	150W	16
SEA-0800600	MB, MW	800	600	31.5	23.62	356 / 1215	300W	16
SEA-1200600	PC, BN, PN, BB, PB, PBC	1200	600	47.24	23.62	431 / 1472	300W	24
SEA-1200600	MB, MW	1200	600	47.24	23.62	534 / 1823	400W	24
SEA-0540500	PC, MB, PB	540	500	21.26	19.69	158 / 538	100W	7
SEA-0480900	PC, MB, BB	480	900	19.9	35.5	207 / 705	150W	8



Intertek

NOTE: Dimensions and specifications are subject to change without notice.



Towel Warmers

PRODUCT SPECIFICATION SHEET

SEATTLE SERIES TOWEL WARMER

Chauffe-serviettes  
Calentador de toallas

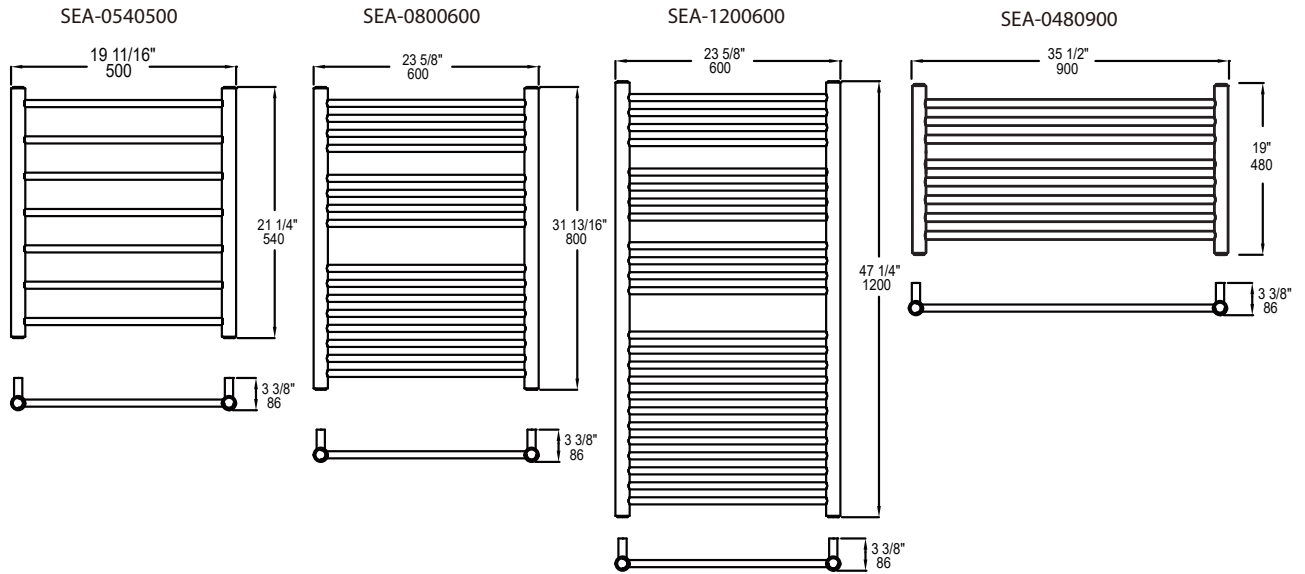

Vernon Towel Warmer Hardwire Kit Round -PC  
Code: VTW-HWK-RD-PC

- 7
- 6
- 5
- 4
- 3
- 2
- 1

1. Solid fixing lug
2. Wall support core
3. Wall screw
4. Allen key
5. Grub screw
6. Wall support
7. Wall plug

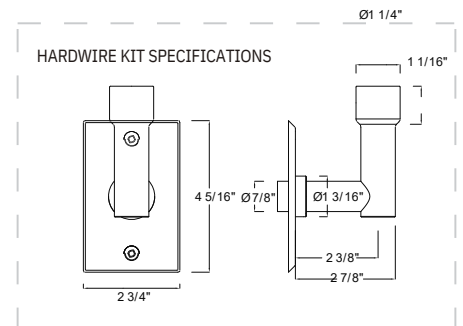
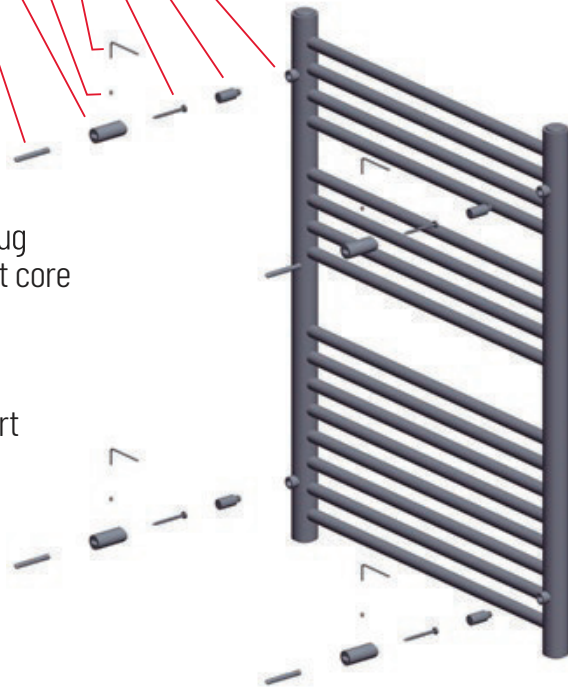

TIMERS AVAILABLE

Visit [vernantowelwarmers.com](http://vernantowelwarmers.com) for details



Intertek

NOTE: Dimensions and specifications are subject to change without notice.













# SEATTLE SERIES TOWEL WARMER

Chauffe-serviettes  
Calentador de toallas

## SPECIAL FINISH ORDER

SEA-0800600



FINISH	CODE	KARTNERS CODE
 Brushed Bronze	BRZ	25
 Brushed Gold	BG	22
 Black Nickel	BNK	40
 Rose Gold	RG	32
 New World Bronze	NWB	80
 Polished Brass	PBS	72
 Antique Nickel	AN	91
 Gunmetal	GM	44
 Polished Gold	PG	12
 Glossy White	GW	62
 Champagne Bronze	CB	30
 Antique Black	AB	45

Our new special finishes seamlessly coordinate with the special finishes offered by Kartners